

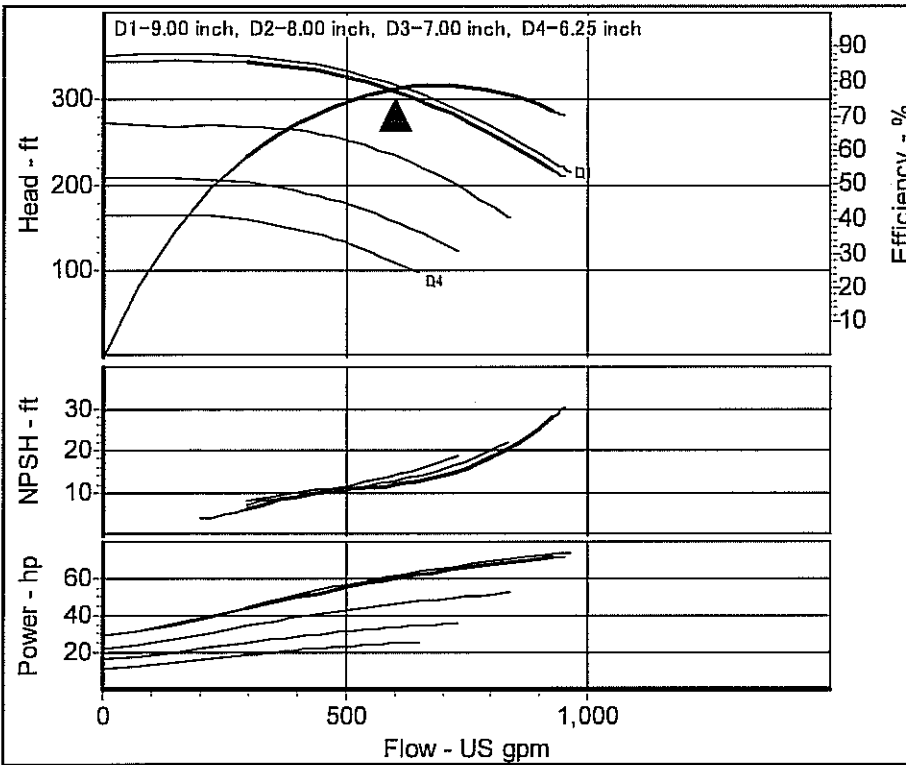

11614 Canyon Trall Dr.
Houston, Texas 77070
Phone: 281-345-8700
Fax: 281-345-2361

Type:	AE Horiz Mtg - Horizontal Split Case Single Stage	Item :	1
Pump Model:	Peerless - 3AE9G	Impeller No.:	2693451
Nom. Speed:	3525 RPM, 60 Hz Electric	Fluid:	Water
Impeller Dia.:	8.91 inch	Temperature:	68 °F
Curve No.:	3132060	Viscosity:	1.007 cSt
Market :	Basic Selection	Sp. Gravity:	1.000
		Your Ref. :	



Duty Flow	600 US gpm
Duty Head	300 ft
Imp. Dia.	8.91 inch
Power Required	60.2 hp
NPSH Required	12 ft
Efficiency	77.8 %
Peak Power	71.1 hp
Closed Valve Head	342.7 ft
Tolerance	Hyd Inst- Peerless Std

Comments

Perf. curve represents typical perf, vel. head is incld. Perf. curves tests are performed in accordance with H.I.Stds.

Flow (US gpm)	Head (ft)	Efficiency (%)	Power Required (hp)	NPSH Required (ft)
295.7	342.2	58.3	43.8	6.3
374.8	338.0	65.9	48.6	8.7
453.9	331.0	71.5	53.1	10.3
532.9	320.6	75.5	57.1	11.2
612.0	306.6	78.0	60.7	12.2
691.1	289.1	78.9	63.9	14.0
770.2	268.1	78.1	66.7	17.0
849.3	243.8	75.6	69.2	21.5
928.4	216.7	71.4	71.1	28.0





Date: March 26, 2014 Quote No.: US-5274-246
 Customer: Webb County Water Utility Model: Peerless - 3AE9G

TERMS	ESTIMATED LEAD TIME	FREIGHT	F.O.B.
TO BE DETERMEND	13 - 14 WEEKS	PP&ADD	SHIPPING POINT

ESTIMATED FREIGHT COST : \$300 - \$500

Flow (US gpm)	Head (ft)	Eff. (%)	Power (hp)	SPEED (RPM)
600	300	77.8	60.2	3525
Liquid	Temp. (F)	SP. Gravity	VISC. (Cst)	DIA. (inch)
Water	68	1.000	1.007	8.91

Summary Quotation:

ITEM No.	Description	Weight	Qty
1	3AE9G - CI/Brz Fit Horiz Mount, Mechanical Seal	265	1
2	CI Casing with 125lb Suct/125lb Disch FF ANSI flanges	0	1
3	Hardware & Gasket for 125lb/125lb Flanged Casing	0	1
4	Bronze Impeller with Integral Rings	0	1
5	Bronze Casing Rings	0	2
6	Standard Grease Lube Bearings	0	1
7	RH Steel Shaft Single Row Outboard Bearing	0	1
8	Single Row Outboard/Inboard Brgs with Std Lip Seals	0	1
9	Bronze Shaft Sleeves (set of 2)	0	1
10	Crane Type 21 Mech Seal 225 F Max BF5010101	0	1
11	Ceramic Seat (Set of 2)	0	1
11	No Mechanical Seal Flush Piping	0	1
12	75Hp 3600Rpm Mfr Std Frame, Horiz Foot Mtd Elect Motor, Customer Furnished	0	0

TOTAL (\$) \$ 6,662.25

*(Peak Power: 71.1 HP - needed)
pumps do not meet spec.*

Now In:

Search Results



NEW Master Catalog 125 available!

Over 1780 pages, 150 pages of new products,
Tech Tips, Operator Notes... Everything You Need!

Click here to view it online today or to request one be sent to you...FREE!



1 - 12 of 6165 Results for: peerless pump horizontal split case

Refine Your Search

<p>By Category:</p> <ul style="list-style-type: none"> Air Filters, Paper (1) Alternators (3) Anti Foam (1) Apparel (17) more 	<p>By Manufacturer:</p> <ul style="list-style-type: none"> 3M (2) ABS Pumps (61) ADMIRAL VALVE COMPANY (8) AK INDUSTRIES (30) more 	<p>By Price:</p> <ul style="list-style-type: none"> Under \$50 (831) \$50 to \$100 (713) \$100 to \$200 (753) \$200 to \$300 (385) more\$ - \$ <input type="button" value="Go"/>
----------------------------------------------------------------------------------------------------------------------------------------------------------------------------------	---------------------------------------------------------------------------------------------------------------------------------------------------------------------------------------	-------------------------------------------------------------------------------------------------------------------------------------------------------------------------------------------------------------------------------------



There were no products that contained all of the words you searched for. The below results contain some of the words.

Results per page:

Grid List

Sort by:

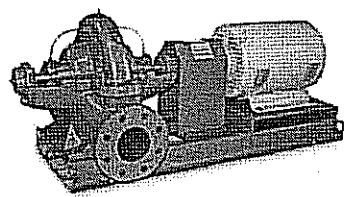
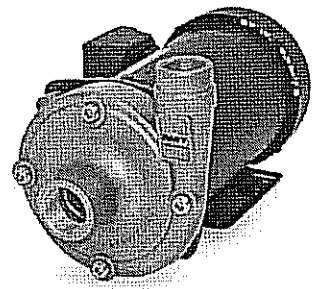
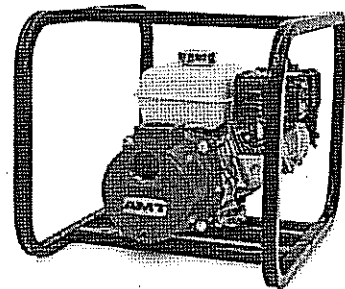
1 2 3 4 5 6 7 8 9 ... Next Last

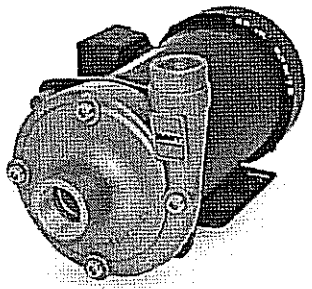
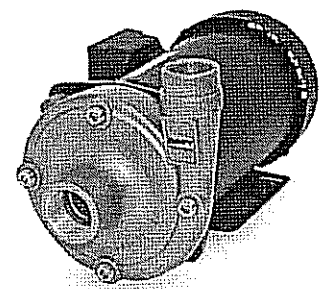
 <p style="font-size: small;">Weinman Split Case Pumps Reference Number #38578 - Catalog Page 1200 CALL FOR PRICING & TO ORDER</p> <p style="text-align: right;"><input type="checkbox"/> Compare</p>	 <p style="font-size: small;">AMT 1-1/4"x1" Centrifugal Pump 0.75hp/230- 460V/3PH, CI case #12782 - Catalog Page 1196 \$409.95</p> <p style="text-align: right;"><input type="checkbox"/> Compare</p>	 <p style="font-size: small;">AMT 2" Trash Pump 3.5HP, B&S, Cast Iron Case #72440 - Catalog Page 1215 \$549.95</p> <p style="text-align: right;"><input type="checkbox"/> Compare</p>
 <p style="font-size: small;">Carry Case for 12 VDC Pump Warren Rupp #36502 - Catalog Page 1144 \$232.95</p> <p style="text-align: right;"><input type="checkbox"/> Compare</p>	 <p style="font-size: small;">AMT 1-1/2x1-1/4 Centrifugal Pump 2HP/230V/1PH CI Case #12800 - Catalog Page 1196 \$509.95</p> <p style="text-align: right;"><input type="checkbox"/> Compare</p>	 <p style="font-size: small;">AMT 1-1/2x1-1/4 Centrifugal Pump 2HP/230- 460V/3PH CI Case #12802 - Catalog Page 1196 \$509.95</p> <p style="text-align: right;"><input type="checkbox"/> Compare</p>

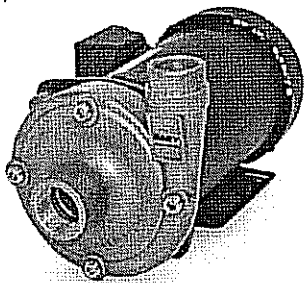

AMT 1-1/2x1-1/4 Centrifugal Pump 3HP/230-460V/3PH CI Case
#12806 - Catalog Page 1196
\$579.95

Compare

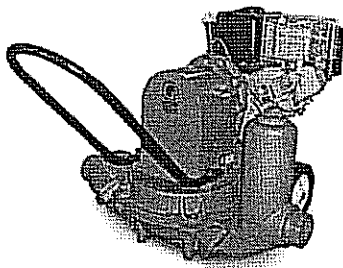

CH&E 5437-WR 2" Diaphragm Pump 4 HP Honda, AL Case
#65465 - Catalog Page 1208
\$1,999.95

Compare

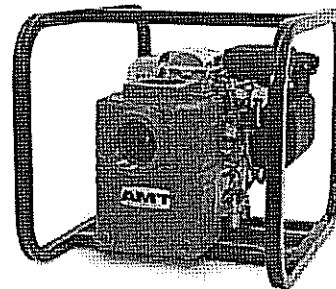

AMT 3" Solids Handling Pump 5HP, Honda, Cast Iron Case
#72445 - Catalog Page 1218
\$764.95

Compare

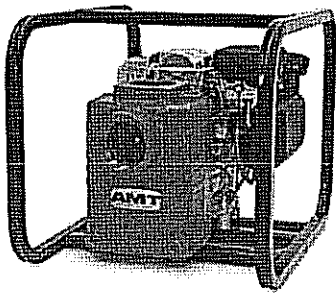

AMT 2" Solids Handling Pump 5.5HP, B&S, Cast Iron Case
#72443 - Catalog Page 1218
\$599.95

Compare

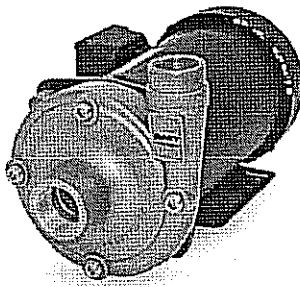

AMT 1-1/2x1-1/4 Centrifugal Pump 3HP/230V/1PH CI Case
#12804 - Catalog Page 1196
\$579.95

Compare

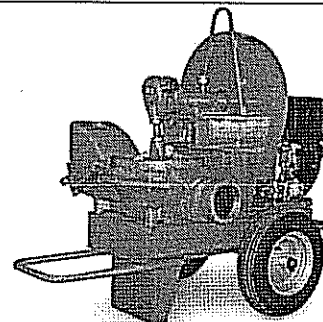

CH&E 5AQ-6W 4" Diaphragm Pump Honda 8HP, Wheels, CI Case
#65521 - Catalog Page 1209
\$6,525.00

Compare

Search preferences

Compare Selected Items
1 2 3 4 5 6 7 8 9 ... Next Last

Search Feedback: Did you find what you are looking for? Yes No

Our Business: Home | About Us | Careers | Catalog Request | Contact Us | Site Map

Resources: Terms & Conditions | Return Policy | Se habla español | World Service

My Account: Account Updates | Order Status | Order & Payment | Shipping & Delivery | Wish List | Help

Items sold by USABlueBook are intended for use only by professionals in the water and wastewater treatment industry. Many items sold by USABlueBook require supplemental training, licenses or permits for proper use and may be harmful if not used properly.

All content © copyright 2014 by HD Supply Facilities Maintenance Ltd., d/b/a/ USABluebook.



Home / peerless pump horizontal split case single stage pump

peerless pump horizontal split case single stage pump

Pumps do not meet specs.

12 Results Found that Include 12 Products

Sort results by:

Grid List | Results per page: 16 | 32 | 48



Pump, Pressure Booster, 1/2 HP
DAYTON
Grainger Item # 5UXG6 | Mfr. Model # 5UXG6
Catalog Page # 3716 (PDF)
Pressure Booster Pump, High-Volume, Motor Enclosure ODP, Housing Material Cast Iron, 1/2 HP, 1 Phase, Voltage... More

Price: \$603.00 / each

Typically In Stock

Qty: 1 Add to Cart

+Add to list

Compare



Pump, Pressure Booster, 1 HP
DAYTON
Grainger Item # 5UXH0 | Mfr. Model # 5UXH0
Catalog Page # 3716 (PDF)
Pressure Booster Pump, High-Volume, Motor Enclosure ODP, Housing Material Cast Iron, 1 HP, 1 Phase, Voltage... More

Price: \$667.50 / each

Typically In Stock

Qty: 1 Add to Cart

+Add to list

Compare



Pump, Pressure Booster, 2 HP
DAYTON
Grainger Item # 5UXJ2 | Mfr. Model # 5UXJ2
Catalog Page # 3716 (PDF)
Pressure Booster Pump, High-Volume, Motor Enclosure ODP, Housing Material Cast Iron, 2 HP, 1 Phase, Voltage... More

Price: \$1,239.00 / each

Typically In Stock

Qty: 1 Add to Cart

+Add to list

Compare



Pump, Pressure Booster, 3/4 HP
DAYTON
Grainger Item # 5UXG7 | Mfr. Model # 5UXG7
Catalog Page # 3716 (PDF)
Pressure Booster Pump, High-Volume, Motor Enclosure ODP, Housing Material Cast Iron, 3/4 HP, 1 Phase, Voltage... More

Price: \$628.50 / each

Typically In Stock

Qty: 1 Add to Cart

+Add to list

Compare

Jose E. Gonzalez

From: Tomas Sanchez
Sent: Friday, May 02, 2014 2:28 PM
To: Jose E. Gonzalez
Cc: Gabino Cerda; Rose C. Flores
Subject: Capital Outlay

Good afternoon Joe,

Please see the attach case number on what I have been waiting to get a quote for a Horizontal Split Case Single Stage Pump. This will not be the exact pump for what the Water Plant has now at the moment. Vendor is **USA Bluebook** and the representative's name I spoke is **Michelle Case Number: PU1789**

Thank You.

*Tomas Sanchez
Webb County Water Utility
515 Martha Drive
Rio Bravo, Texas. 78046*

*Main Office (956) 523-5590
Direct Number (956) 523-5586
Fax (956) 724-7906*

QUOTATION
HDSEM
D/B/A USABLUBOOK
 PO Box 9004
 Gurnee, IL 60031-9004
 Toll free: 1-800-548-1234
 Fax: (847) 689-3030

NO. 654088
 Page 1
 04/14/14

Ship-to: 1
WEBB COUNTY WATER UTILITY

 513 MARTHA DR
 LAREDO, TX 78046
 USA

Bill-to: 911858
WEBB COUNTY
PURCHASING DEPT
 1110 WASHINGTON ST STE 101
 LAREDO TX 78040-4466
 USA

REFERENCE #	EXPIRES	SLSP	TERMS	WH	FREIGHT	SHIP VIA
041414	05/14/14	MAC	NET 30	50	FXD/PPD	UPS

QUOTED BY: MAC | QUOTED TO: JUAN VAZQUEZ

ITEM	DESCRIPTION	QUANTITY	UM	PRICE	UM	EXTENSION
48951	Air Powered Chain Saw w/20 in Bar & Chain **LEAD TIME IS ABOUT 1 WEEK**	1	EA	3891.15	EA	3891.15
48953	Pipe Clamp with Mounting Axle for Chain Saws	1	EA	346.70	EA	346.70

Please note that your order may be subject to applicable taxes based on current rates at the time your order is completed.

TO ORDER --

For your convenience, you may simply sign below and return via fax to 847-689-3030. We will process your order promptly and fax a confirmation so you know we have it. If you prefer to call your order in or have additional questions or concerns, you may contact our Customer Service Department @ 800-548-1234. Please note any changes to the quantities or shipping address. Thanks for choosing USABluBook.

Authorization Signature _____

PO Number (if required) _____

MERCHANDISE	MISC	TAX	FREIGHT	TOTAL
4237.85	.00	.00	35.45	4273.30

USE THIS QUOTE # ON PO's!



Home / Outdoor Equipment / Cutting and Pruning Tools / Chain Saws

do not meet specs

Chain Saws

7 Results Found that Include 30 Products

**OUT WITH THE OLD
IN WITH THE**
Makita

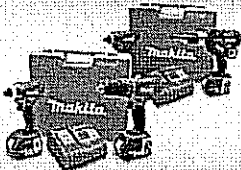

Save on popular Makita Combo Kits plus get an **ADDITIONAL \$100 OFF** with your trade-in! Only at Grainger!

Offer Ends 8/30/14



Sort results by: **Top Sellers**

Grid | List | Results per page: 16 | 32 | 48



Chain Saw
ECHO
Multiple product options available

Price: \$288.00 - \$781.50
[View All 13 Products](#)

[Quick View Most Popular Products](#)



Chain Saw
MAKITA
Multiple product options available

Price: \$278.04 - \$1,102.00
[View All 8 Products](#)

[Quick View Most Popular Products](#)



Chain Saw Bar Cover
TRUE NORTH
Multiple product options available

Price: \$73.20 - \$76.40
[View All 4 Products](#)

[Quick View Most Popular Products](#)



Chain Saw, Gas, 20 in. Bar, 59.8cc
ECHO

Granger Item # 20KC05 | Mfr. Model # CS-590-20
Catalog Page # NA

Chain Saw, Fuel Type Gas, Bar Length 20 In., Engine Displacement 59.8cc, 3.9 HP, Auto/Adjustable Chain Oiler, ... More

Price: \$539.50 / each
Product ships within 4 business days from supplier

Qty: 1 [Add to Cart](#)
[+Add to list](#)

Compare



Home / pneumatic saw / Pneumatics

Pneumatics

13 Results Found that Include 18 Products

Sort results by: **Top Sellers**

Grid | List | Results per page: 16 | 32 | 48



Reciprocating Air Saw
INGERSOLL-RAND
Multiple product options available

Price: \$166.25 - \$262.25
[View All 2 Products](#)

[Quick View Most Popular Products](#)



Reciprocating Air Saw
CHICAGO PNEUMATIC
Multiple product options available

Price: \$207.25 - \$318.50
[View All 3 Products](#)

[Quick View Most Popular Products](#)



Reciprocating Air Saw
SPEEDAIRE
Multiple product options available

Price: \$86.04 - \$266.25
[View All 3 Products](#)

[Quick View Most Popular Products](#)



Circular Saw, General
VIKING AIR TOOLS
Grainger Item # 29CK40 | Mfr. Model # VT7502
Catalog Page # NA
Circular Saw, General, 4 Average CFM @ 15 Second Run
Time, 4 CFM @ Full Load, Required Pressure 90 psi, Air...
[More](#)

Price: \$349.50 / each
Product ships within 6 business days from supplier

Qty: [Add to Cart](#)
[+Add to list](#)

Compare



Home / pneumatic chain saw

pneumatic chain saw

1 Result Found that Includes 1 Product

You searched for "neumatic chain saw".
No matching results were found for this term.
Your term has been auto-corrected to "pneumatic chain saw".
Please re-try your search if this is not the correct term.

Sort results by:

Grid List | Results per page: 16 | 32 | 48



Pipe Hacksaw Extension Chain, 45 In. L

FEIN

Grainger Item # 10F001 | Mfr. Model # 30231008000

Catalog Page # 1006 (PDF)

Pipe Hacksaw Extension Chain, Length 45 In., Width 1 In. For Use With Mfg. Model STS 325R Pneumatic Hacksaw,... [More](#)

Price: \$229.50 / each

Product ships within 6 business days from supplier

Qty: [Add to Cart](#)

[+Add to list](#)

Compare

Grid List | Results per page: 16 | 32 | 48

Sort results by:



do not meet spec

Search Within:
"air concrete saws"

Search Results

148 Items

AIR CONCRETE SAWS

Items per page: 24 96 Sort by: **Most Popular**

<< < 1 2 3 4 5 > >>

Categories

- Air Tools (17)
- Construction (128)
- Power Tools (3)

Brand

- Klutch (8)
- Husqvarna (48)
- Norton (37)
- National Diamond (15)
- Northern Industrial Tools (11)
- 12 More...

Price

- \$5 - \$10 (3)
- \$10 - \$20 (12)
- \$20 - \$50 (14)
- \$50 - \$100 (15)
- \$100 - \$250 (32)
- \$250 - \$500 (36)
- Over \$500 (36)

Save On "air concrete saws"

- All Deals (97)
- On Sale (3)
- Free Shipping (95)
- Clearance (1)

Compare Item# 20965

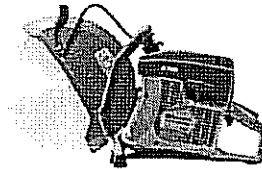

Husqvarna Handheld Power Cutter — 14in. Blade, 74cc Gas Engine, Model# K76Q II-14in.

★★★★★ (3)

Was \$919.99

Sale \$899⁹⁹

Saves \$20.00

Add to Cart

Compare Item# 157641



Northern Industrial Tools Replacement Air Body Saw Blades — 5 Pack, 24 Teeth/in.

★★★★★ (2)

Only \$6⁹⁹

Add to Cart

Compare Item# 15754



Video

Northern Industrial Tools Air Body Saw — 4 CFM, 90 PSI, 10,000 Strokes/Min.

★★★★★ (18)

Only \$59⁹⁹

Add to Cart

Compare Item# 154386



Video

Ingersoll Rand Air Reciprocating Saw, Model# 429G

★★★★★ (4)

Only \$109⁹⁹

Add to Cart

Compare Item# 157937

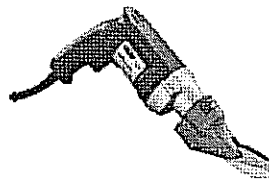

FREE SHIPPING — Kett Electric Fiber Cement Cutting Shears — 120 Volt, 5 Amp, Model# KD-29

★★★★★ (1)

Only \$189⁹⁹

Add to Cart

Compare Item# 157793

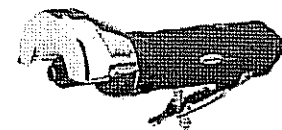

Northern Industrial Air Cutoff Tool — 3in. Wheel, 3 CFM

★★★★★ (10)

Only \$39⁹⁹

Add to Cart

Compare Item# 159615

Compare Item# 28449

Compare Item# 157640

Jose E. Gonzalez

From: Tomas Sanchez
Sent: Friday, May 02, 2014 3:12 PM
To: Jose E. Gonzalez
Subject: RE: Capital Outlay

Joe,

One of this quotes is cheaper than US Bluebook. We do have an account with Grainger.

Thank You.

*Tomas Sanchez
Webb County Water Utility
515 Martha Drive
Rio Bravo, Texas. 78046*

*Main Office (956) 523-5590
Direct Number (956) 523-5586
Fax (956) 724-7906*

From: Jose E. Gonzalez
Sent: Friday, May 02, 2014 2:55 PM
To: Tomas Sanchez
Subject: RE: Capital Outlay

Are these quotes cheaper than USABLUBOOK?

From: Tomas Sanchez
Sent: Friday, May 02, 2014 2:52 PM
To: Jose E. Gonzalez
Cc: Gabino Cerda; Rose C. Flores
Subject: Capital Outlay

Joe,

Please see two more quotes for the Air Powered Chain Saw. Attach are the quotes. Please add to the Capital Outlay request.

Thank You.

Products Please input a keyword Advanced Search

or Post Buying Request

Home > Products > Security & Protection > Other Security & Protection Products (114644)

Multi-Language Sites

Pneumatic Diamond Chain Saw

Verified Supplier - Beijing Linglian Shiji Automatic Technology Co., Ltd.

FOB Price: US \$7,000 - 8,000 / Piece [Get Latest Price](#)

Mn. Order Quantity: 1 Piece/Pieces

Supply Ability: 50 Piece/Pieces per Month

Port: Tianjin

Payment Terms: T/T

China (Mainland) | Manufacturer, Trading Company | Contact Details

Experience: Established 2009

Performance: 81.9% Quick Response Rate

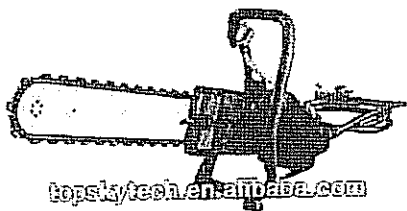

See larger image

Request a quote

Leave Messages

Start Order Add to Inquiry Cart

Add to My Favorites

Not exactly what you want? Post a quick Buying Request!

You May Like:



120 Minutes Compressed Oxygen Self-Priming Pump
US \$200 - 300 / Piece
1 Piece/Pieces



Self-Contained Closed Circuit Breaker
US \$800 - 2000 / Piece
1 Piece/Pieces

45 Minutes Compressed Oxygen Self-Priming Pump
US \$100 - 200 / Piece
1 Piece/Pieces

Report Suspicious Activity

Product Detail Company Profile

Quick Details

Place of Origin:	Beijing China (Mainland)	Brand Name:	TOPSKY	Model Number:	JQL-10/6000
Rated speed of spindle:	≥6000 r/min	rated pressure:	≤0.7 Mpa	Power:	air
Max. bar length:	430mm	Max. cutting Depth:	400mm		

Packaging & Delivery

Packaging Detail: protective box
Delivery Detail: 10days

Specifications

High torque output 6000 r/min
Diamond chain
Deep plunge cuts
No gas or engine fumes to deal with

Applications:

Cut with ease, speed and portability through Reinforced Concrete, Brick, Block, Concrete Pipe and Natural Stone. The powerful JQL-10/6000 pneumatic chain saw is designed to cut through walls, floors and columns in a single pass.

The unique versatility of a concrete cutting chain saw includes the ability to cut small mechanical openings, deep plunge cuts (up to 40cm deep), perfect corners and an endless variety of irregular shapes that are simply not possible with circular saws.

While other folks are cutting with ordinary saws, you can be cutting faster, cheaper and more reliably with the JQL-10/6000 pneumatic chain saw.

Order Together, Save Together!
Buy From Group Deals

GRAINGER

||||| **2014 THE OFFICIAL MRO BUYER'S GUIDE**

Product Categories

- Abrasives
- Adhesives, Sealants and Tape
- Cleaning
- Electrical
- Electronics, Appliances, and Batteries
- Fasteners
- Fleet and Vehicle Maintenance
- Furniture, Hospitality and Food Service
- HVAC and Refrigeration
- Hand Tools
- Hardware
- Hydraulics
- Lab Supplies
- Lighting
- Lubrication
- Machining
- Material Handling
- Motors
- Office Supplies
- Outdoor Equipment
- Paint, Equipment and Supplies
- Plumbing
- Pneumatics
- Power Tools
- Power Transmission
- Pumps
- Raw Materials
- Reference and Learning Supplies
- Safety
- Security
- Test Instruments
- Welding



Free email offers

Your connection to what's new at Grainger. Sign Up for Email Now!

Email Address

Go



Take Full Advantage of Your Contract
TXMAS-2-539030

TEXAS GOVERNMENT TEAM
Phone (512) 837-7440
Fax (512) 837-2041
texas@grainger.com

State Contact Info:
Email address to:
txmas@cpa.state.tx.us

Products



Hydraulic Chain Saw, Standard, 16 In Bar

GREENLEE

Price: \$1,510.34 / each

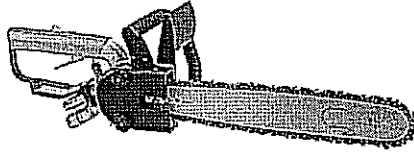

Typically in Stock

Add Repair & Replacement Coverage for \$202.03 each.

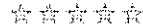

Item # 5NWJ5

Mfr. Model # HCS816

UNSPSC # 27112709

Catalog Page # 3495

Shipping Weight 13.46
lbs.

Country of Origin USA Country of Origin is subject to change.

Repair Parts Available for this item

Technical Specs

Item	Hydraulic Chain Saw	Max. Flow GPM	8
Type	Standard Reach	Recommended Filtration (microns)	10
Hydraulic System Type	Open or Closed Center	Relief Valve PSI Setting	2000
Cutting Capacity	16"	Max. Back Pressure	200 psi
Chain Speed @ 4 GPM	1814 fpm	Max. Oil Temp.	140 Degrees F
Chain Speed @ 8 GPM	3527 fpm	Viscosity (SUS @ 100 F)	140 to 225
Chain Pitch	0.375"	Viscosity (SUS @ 210 F)	40 min.
Pressure Port	9/16"-18 SAE O-Ring	Length	31-1/2"
Return Port	3/4"-16 SAE O-Ring	Width	10"
Min. Flow (GPM)	4	Depth	8-1/2"
Recommended Hydraulic Flow	6 gpm	Weight	9.5 lb.

Compliance and Restrictions

None

Documentation

Greenlee Chain Saws Instruction Manual

Repair Parts

Displaying repair parts for model: HCS916

1Part Available

Mr. Part#	Part Description	Brand	Item#	Availability	Price	Qty
55141	Chain Saw Bar,16 In,For 5NWJ5	GREENLEE	5NWJ6	Typically in Stock	\$153.73 / each	

1Part Available

Related Products

1 of 2 Prev | Next

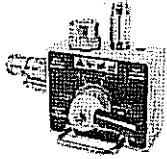

Hyd Flow Control Valve, 30 gpm, 3000 psi
Item # 5NWK6
GREENLEE

Price:\$1,088.21

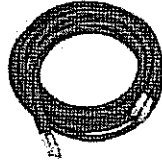

Double Hose Assembly, 1/2x25 Ft, 2000 PSI
Item # 5NWK7
GREENLEE

Price:\$323.91



Saw Chain, 16 in., 3/8 in. Pitch
Item # 5NWJ7
GREENLEE

Price:\$47.53



Chain Saw Bar, 16 In, For 5NWJ5
Item # 5NWJ6
GREENLEE

Price:\$153.73

Product Reviews Disclaimer:

Grainger is neither responsible for, nor does it endorse, the content of any product review or statement posted. Any statements posted constitute the statements of the poster and are not the statements of Grainger. The statements posted by Grainger employees with the Grainger employee badge represent the views of such employees and are not the statements of Grainger. Grainger makes no representations as to the appropriateness, accuracy, completeness, correctness, currentness, suitability, or validity of any product review or statements posted, including those posted by employees with the Grainger employee badge, and is not liable for any losses, injuries or damages which may result from any such product review or statements. Use of any linked web site provided in a product review or post is at the user's own risk.

1 of 1

Ask and Answer Disclaimer:

Grainger is neither responsible for, nor does it endorse, the content of any statement posted. Any statements posted constitute the statements of the poster and are not the statements of Grainger. The statements posted by Grainger employees with the Grainger employee badge represent the views of such employees and are not the statements of Grainger. Grainger makes no representations as to the appropriateness, accuracy, completeness, correctness, currentness, suitability, or validity of any statements posted, including statements posted by employees with the Grainger employee badge, and is not liable for any losses, injuries or damages which may result from any such statements.

Use of any linked web site provided in a post is at the user's own risk. This site should not replace the use by you of any technical product manual or other professional resource or adviser available to you.

The source for the answers given by Grainger in Ask and Answer are based on the information provided with the question, which may not be complete or may not apply to other situations, and based on product literature and informational materials, the content of which is provided by Grainger's product suppliers. Grainger disclaims liability for any information it provides in Ask and Answer which later may be alleged or determined by a court of law to be inaccurate or incorrect.

The answers given by Grainger in Ask and Answer are not intended to replace or supplement any professional, engineering or other consultation services available to its product users. Always read, understand, and follow the product information and instructions provided by the manufacturer. same on category AAA as well

Delta House Elect. & Motor Rewind, INC

PO Box 1032
 212 Forrest St
 Freer, TX 78357
 US

Voice: 361-394-7746
 Fax: 361-394-1466

QUOTATION

Quote Number: 993
 Quote Date: Apr 15, 2014
 Page: 1

Quoted To:

Webb County Utilities Department
 513 Martha Drive
 Rio Bravo, TX 78046

Customer ID	Good Thru	Payment Terms	Sales Rep
Webb County	5/15/14	Net 30 Days	

Quantity	Item	Description	Unit Price	Amount
	Labor and Parts	Sale of new Centrifugal pump with 20 HP Baldor- Reliance TEFC motor <u>3480 RPM</u> 208-230/460 V. Labor and Parts Estimated Delivery 3 Weeks		3,950.00
			Subtotal	3,950.00
			Sales Tax	
			TOTAL	3,950.00



Log In | My Account | Wish List | Cart: 0

Products | Contact Us | Resources | Help

Search input field with a 'Go' button

Now In: Pumps / Centrifugal Pumps, Self Priming / Gusher Self Priming Pump 6 in x 6 in 20 hp motor

Not Baldor - Reliance motor

Gusher Self Priming Pump 6 in x 6 in 20 hp motor

E-mail this product to a friend

- Totally interchangeable with Gorman Rupp's T series pumps
- Self priming up to 25'
- Models available with 3" solids handling capability

Item: 73171
Weight: 1000.0 lbs
CALL FOR PRICING & TO ORDER

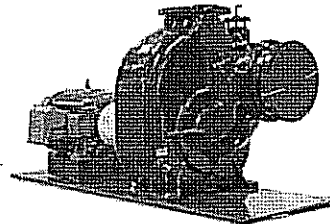

Gusher self-priming centrifugal pumps are ideal for industrial and sewage applications—everything from small subdivisions to large waste collection systems. They are completely interchangeable with Gorman Rupp's T series pumps—install new, or rebuild your existing pumps using the replacement rotating assembly.

The pumps' large-volute design allows them to re-prime automatically without suction or discharge check valves. Self priming is achieved with the pump casing only partially filled with liquid and with a completely dry suction line. Maintenance is easy with complete access to the pumps' rotating assembly.

USABlueBook carries a wide selection of Gusher pumps, including different sizes and impellers, and speed variations. All pumps come pre-assembled and ready to install. To order, you must supply your desired flow rate or rpms. Our technical support representatives will make sure you receive the correct pump pulley for your application.

Includes: motor and base. Bareshaft models are available as special order; contact USABlueBook for more details.

[View larger image](#)

Catalog Page 1202

Tech Specs	Related Products	Recently Viewed Products
<p>Gusher Self Priming Pump 6 inch pump rotating assembly</p> <p>\$2,371.10</p>		

Our Business: Home | About Us | Careers | Catalog Request | Contact Us | Site Map

Resources: Terms & Conditions | Return Policy | Se habla español | World Service

My Account: Account Updates | Order Status | Order & Payment | Shipping & Delivery | Wish List | Help

Items sold by USABlueBook are intended for use only by professionals in the water and wastewater treatment industry. Many items sold by USABlueBook require supplemental training, licenses or permits for proper use and may be harmful if not used properly.

All content © copyright 2014 by HD Supply Facilities Maintenance Ltd., d/b/a/ USABluebook.

Now In:

Search Results



NEW Master Catalog 125 available!

Over 1780 pages, 150 pages of new products,
Tech Tips, Operator Notes... Everything You Need!

Click here to view it online today or to request one be sent to you...FREE!



1 - 5 of 5 Results for: 20 hp centrifugal pump

Results per page: 12

Grid List

Sort by: Relevance

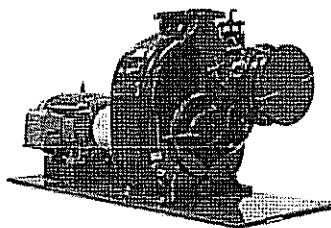
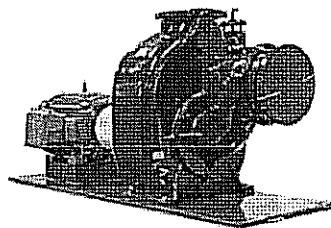
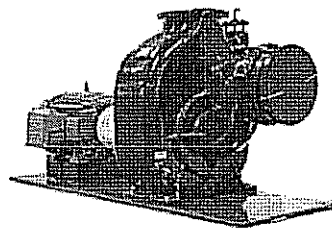
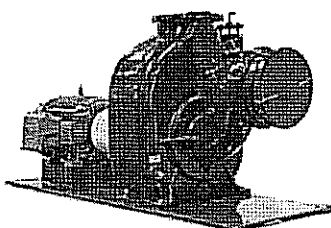
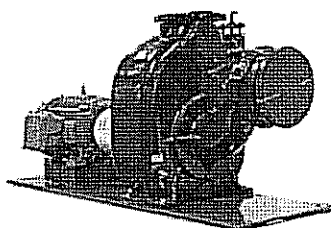
		
<p>Gusher Self Priming Pump 3 in x 3 in 20 hp motor #73161 - Catalog Page 1202 CALL FOR PRICING & TO ORDER</p> <p><input type="checkbox"/> Compare</p>	<p>Gusher Self Priming Pump 6 in x 6 in 20 hp motor #73171 - Catalog Page 1202 CALL FOR PRICING & TO ORDER</p> <p><input type="checkbox"/> Compare</p>	<p>Gusher Self Priming Pump 8 in x 8 in 20 hp motor #73176 - Catalog Page 1202 CALL FOR PRICING & TO ORDER</p> <p><input type="checkbox"/> Compare</p>
		
<p>Gusher Self Priming Pump 4 in x 4 in 20 hp motor #73166 - Catalog Page 1202 CALL FOR PRICING & TO ORDER</p> <p><input type="checkbox"/> Compare</p>	<p>Gusher Self Priming Pump 2 in x 2 in 2.0 hp motor #73152 - Catalog Page 1202 CALL FOR PRICING & TO ORDER</p> <p><input type="checkbox"/> Compare</p>	

[Compare Selected Items](#)

[Search preferences](#)

Search Feedback: Did you find what you are looking for? Yes No

Our Business: [Home](#) | [About Us](#) | [Careers](#) | [Catalog Request](#) | [Contact Us](#) | [Site Map](#)

Resources: [Terms & Conditions](#) | [Return Policy](#) | [Se habla español](#) | [World Service](#)

My Account: [Account Updates](#) | [Order Status](#) | [Order & Payment](#) | [Shipping & Delivery](#) | [Wish List](#) | [Help](#)

Items sold by USABlueBook are intended for use only by professionals in the water and wastewater treatment industry. Many items sold by USABlueBook require supplemental training, licenses or permits for proper use and may be harmful if not used properly.

All content © copyright 2014 by HD Supply Facilities Maintenance Ltd., d/b/a/ USABluebook.



[Products](#) | [Contact Us](#) | [Resources](#) | [Help](#)

[Login](#) | [My Account](#) | [Wish List](#) | [Cart: 0](#)

Now In: [Pumps / Centrifugal Pumps, Self Priming / Gusher Self Priming Pump 6 in x 6 in 20 hp motor](#)

Gusher Self Priming Pump 6 in x 6 in 20 hp motor

[E-mail this product to a friend](#)

- Totally interchangeable with Gorman Rupp's T series pumps
- Self priming up to 25'
- Models available with 3" solids handling capability

Item: 73171
 Weight: 1000.0 lbs
CALL FOR PRICING & TO ORDER

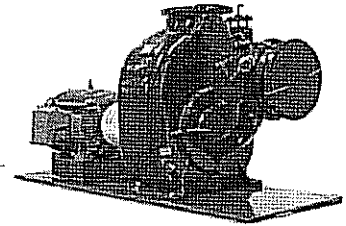

Gusher self-priming centrifugal pumps are ideal for industrial and sewage applications—everything from small subdivisions to large waste collection systems. They are completely interchangeable with Gorman Rupp's T series pumps—install new, or rebuild your existing pumps using the replacement rotating assembly.

The pumps' large-volute design allows them to re-prime automatically without suction or discharge check valves. Self priming is achieved with the pump casing only partially filled with liquid and with a completely dry suction line. Maintenance is easy with complete access to the pumps' rotating assembly.

USABlueBook carries a wide selection of Gusher pumps, including different sizes and impellers, and speed variations. All pumps come pre-assembled and ready to install. To order, you must supply your desired flow rate or rpm. Our technical support representatives will make sure you receive the correct pump pulley for your application.

Includes: motor and base. Bareshaft models are available as special order; contact USABlueBook for more details.

[View larger image](#)

Catalog Page 1202

[Related Accessories](#) | [Related Products](#) | [Recently Viewed Products](#)

Size: 6 x 6
 hp: 20
 Solids handling: maximum 3" diameter (depending on size of pump)
 Construction: ductile iron, 316 SS, 316 SS fitted, or CD4M|Impeller: A60-40-18|Bearings: SKF roller bearings|Seals: cartridge type, packed, single mechanical or double mechanical|Motor: TENC, 230/460V, 3 phase|Shaft material: ANSI-414DHT|Maximum temperature: 450°F

Our Business: [Home](#) | [About Us](#) | [Careers](#) | [Catalog Request](#) | [Contact Us](#) | [Site Map](#)

Resources: [Terms & Conditions](#) | [Return Policy](#) | [Se habla español!](#) | [World Service](#)

My Account: [Account Updates](#) | [Order Status](#) | [Order & Payment](#) | [Shipping & Delivery](#) | [Wish List](#) | [Help](#)

Items sold by USABlueBook are intended for use only by professionals in the water and wastewater treatment industry. Many items sold by USABlueBook require supplemental training, licenses or permits for proper use and may be harmful if not used properly.

All content © copyright 2014 by HD Supply Facilities Maintenance Ltd., d/b/a/ USABluebook.



General Purpose Motor, Totally Enclosed Fan-Cooled

BALDOR ELECTRIC
Technical Specs

1/2, 3, 5 HP only

**Photo
Not
Available**

Item:	General Purpose Motor
Motor Type:	3-Phase
Enclosure:	Totally Enclosed Fan-Cooled
Voltage:	208-230/460
Thermal Protection:	None

Keyword: 20 hp baldor motor

HP	RPM Range	Nameplate RPM	Frame	Mounting	Full Load Amps	Shaft Length
10	1101-1200	1160	215T	Face/Foot	15.3-14.6/7.3	3-1/8"
5	1701-1800	1770	215TC	Foot	25.4-24/12	3-19/60"

2 Products

Product #	HP	RPM Range	Nameplate RPM	Frame	Mounting	Full Load Amps	Availability	Price
24TT77	10	1701-1800	1770	215T	Foot	25.4-24/12	Item ships within 5 business days from supplier	\$1,850.00 / each
29UX52	5	1101-1200	1160	215TC	Face/Foot	15.3-14.6/7.3	Item ships within 4 business days from supplier	\$1,908.00 / each

Customers Also Viewed

1 of 4 Prev | Next



Motor, 3-Ph, 5 HP, 1750 RPM, 184T, TEFC
Item # 39E467
BALDOR ELECTRIC

Price: \$917.00

Add to Cart



Motor, 3-Ph, TEFC, 1/2HP, 1725 RPM, Face/Foot
Item # 29UX64
BALDOR ELECTRIC

Price: \$421.25

Add to Cart



Mtr, 3 Ph, 5 HP, 1750, 208-230/460V, Eff 89.5
Item # 4GZA4
DAYTON

Price: \$533.00

Add to Cart



Mtr, 3 Ph, 3 HP, 1760, 208-230/460V, Eff 89.5
Item # 2MXU4
DAYTON

Price: \$681.00

Add to Cart

Customers Also Purchased

Jose E. Gonzalez

From: Tomas Sanchez
Sent: Friday, May 02, 2014 2:05 PM
To: Jose E. Gonzalez
Cc: Gabino Cerda; Rose C. Flores
Subject: Capital Outlay 20hp Pump
Attachments: CASE PU1786 - for tomas.htm

Good afternoon Joe,

Please see attached quote for where USA Bluebook is saying they do not handle this types of Pumps. Please see attachments. Please attach to the Capital Outlay request.

Thank You.

*Tomas Sanchez
Webb County Water Utility
515 Martha Drive
Rio Bravo, Texas. 78046*

*Main Office (956) 523-5590
Direct Number (956) 523-5586
Fax (956) 724-7906*

Navigation

- Mail
- Calendar
- Contacts
- Collapse Navigation Pane

Content Area Control

- Deleted Items (102)
- Drafts (148)
- Inbox (1070)
- Junk E-mail (2)
- Sent Items
- Click to view all folders
- Bulk mail
- Manage Folders...

Search

Type here to search This Folder Search

Settings, Address Book, and Help

Address Book Options Help Log Off

Toolbar

Reply Reply to All Forward Move Delete Junk Close Previous Item Next Item Close

Content Area

CASE PU1786
 Windler, David B [HDS] [dwindler@usabluebook.com]
 Sent: Friday, May 02, 2014 11:57 AM
 To: Javier J. Garcia
 Javier

We do not handle the Aurora pump line. Aurora has a very tightly controlled system of regional reps and distributors and they don't permit them to cross territorial lines.
 They definitely won't deal with a nationwide distributor like us.
 Sorry we could not help you with this application.

Thank you

Dave Windler
 USABlueBook
 Technical Support
EVERYTHING You Need for Water & Wastewater Operations and Maintenance!

Office: 800-925-8399 X76994
 847-689-3000 X76994
 Fax: (847) 689-3002
 dwindler@usabluebook.com
 "http://www.usabluebook.com/" title="http://www.usabluebook.com/">www.usabluebook.com

CONFIDENTIALITY NOTICE: This message is for intended addressee(s) only and may contain confidential, proprietary or privileged information, exempt from disclosure, and subject to terms at <http://www.usabluebook.com/email>

Paging and Bottom Toolbar

Previous Item Next Item

Connected to Microsoft Exchange

cannot display this picture



Link Industrial Americas, LLC

PO Box 1783
 1200 E. Tamarack Ave.
 McAllen, TX 78501
 USA

Voice: (956) 618-3684
 Fax: (956) 618-3646

✓ # 26174

QUOTATION

Quote Number: 0690
 Quote Date: Mar 25, 2014
 Page: 1

Quoted To:
CASH CUSTOMER

7-9 weeks delivery

Customer ID	Good Thru	Payment Terms	Sales Rep
CASH CUSTOMER	4/24/14	C.O.D.	

Quantity	Item	Description	Unit Price	Amount
1.00	GGGDCCA-LK	DUROFLOW 7018-HL STD PLUS FREIGHT CHARGES Delivery time: 7-9 weeks	12,735.00	12,735.00

quote still valid?
MAY - 1 2014

Subtotal	12,735.00
Sales Tax	1,050.64
TOTAL	13,785.64

Jose E. Gonzalez

From: Gabino Cerda
Sent: Tuesday, April 08, 2014 9:40 AM
To: Jose E. Gonzalez
Cc: Tomas Sanchez; Heladio Izaguirre
Subject: FW: Blower Quote
Attachments: U40326-B1 Webb County.pdf

V# 20268

The other company I contacted and they do not have it in stock is USABUEBOOK 1-800-548-1234.

Please set up Universal Blower Pac. Their number is 317-773-7256.

Thanks,

Gabino Cerda

Wastewater Superintendent
Webb County Water Utility
515 Martha Dr.
Rio Bravo, Texas 78046
(956) 523-5594
Fax (956) 724-7906

From: Gabino Cerda
Sent: Tuesday, April 08, 2014 9:37 AM
To: Jose E. Gonzalez
Cc: Tomas Sanchez
Subject: FW: Blower Quote

This company has a delivery time of 4 weeks the other company has a delivery time of 7-9 weeks.

Thank you,

Gabino Cerda

Wastewater Superintendent
Webb County Water Utility
515 Martha Dr.
Rio Bravo, Texas 78046
(956) 523-5594
Fax (956) 724-7906

**Purchase Requisition
County of Webb**



Department Water Utilities
 Requisitioned By Tomas Sanchez
 Phone No. (956) 523-5586

Req. Number 04/16/2014
 Req. Date HOLT Power System CAT
 Deliver To

Capital Outlay (Attach Minutes)	
Court Approval Date	Item #

**E-Mail Standard
Purchase Requisition**

E-Mail Capital Outlay Requisition

Official's Affidavit
 I hereby certify that there is an available balance in my approved budget for the current year sufficient to pay for the item(s) requested and that the items are absolutely necessary for the discharge of my official duties.
 Submitting this form from Appropriate Official's E-Mail Constitutes Signature
 Elected Appointed Official's Signature
[Signature] 4/18/14

ACCOUNT NUMBER	COMMODITY CODE	ITEM DESCRIPTION	QTY.	PRICE PER UNIT	DATE NEEDED BY	PURPOSE	AMOUNT
603-0101-8801	28-285-390	Schedule Maintenance for the 3 Generator (2) for the Water Treatment Plant and (1) for the Wastewater Treatment Plant	3	\$11,125.00	04/18/2014	For the Emergency Use at the Water Treatment Plant and at the Wastewater Treatment Plant	\$33,375.00
603-0101-8801	28-285-390	Transfer Switch at the Water Treatment Plant for the Generators	1	\$35,587.90	ASAP	To replace the Transfer Switch that failed and parts to get Generators ready to work for any Power Outage	\$35,587.90
TOTAL AMOUNT							\$68,962.90

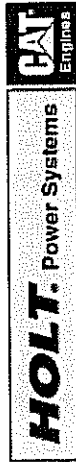

CUSTOMER SUPPORT AGREEMENT

Webb County Water Plant
 Gabino Cerda
 gcerda@webbcountytx.gov
 956.723.9708

Holt CAT Contact # Buy Board 42443 Expires 9-2016

April 11, 2014

Holt Power Systems is pleased to offer you a Scheduled Maintenance program for your emergency generator(s) at your location. Holt follows NFPA 110 and manufacturer's recommendations in maintaining stand-by generators. As stated and recommended, PM Level 1 services should be performed on a quarterly basis, PM Level 2 services should be performed on an annual basis and PM Level 3 services should be performed once every three years. In addition, it is recommended that a minimum two (2) hour Load Bank Test be performed in conjunction with the annual services, when the load on the generator is less than 30% of the name plate rating on the generator. Please reference the attached "Detailed Description of Service Levels" to provide you with an accurate definition of the service levels mentioned herein.

Maintenance pricing for your generator(s) is as follows:

HOLT ID	MANF.	KW	QUARTERLY INSPECTION		ANNUAL SERVICE PM2 PRICE EACH	TRIENNIAL SERVICE PM3 PRICE EACH	LOAD BANK TESTING ANNUAL PRICE EACH	AUTOMATIC TRANSFER SWITCH PM PRICE EACH	FUEL SAMPLE ANNUAL PRICE EACH	YEARLY TOTALS
			PM1 PRICE EACH	QTY.						
ZBA00179	AA	1400	\$ 375.00	3	\$ 1,125.00	\$ 8,500.00	\$ 1,500.00	\$ -	\$ -	\$11,125.00
ZBA00180	AA	1400	\$ 375.00	3	\$ 1,125.00	\$ 8,500.00	\$ 1,500.00	\$ -	\$ -	\$11,125.00
ZBA00189	AA	1400	\$ 375.00	3	\$ 1,125.00	\$ 8,500.00	\$ 1,500.00	\$ -	\$ -	\$11,125.00

For a total Agreement price of: **\$33,375.00**
 To be billed as services rendered

NOTE:

- *The Tri-Annual service (PM3) is performed once every three years in place of the Annual service (PM2).
- *All listed pricing includes normal hour labor rates, travel & applicable parts. Additional charges will apply for after-hours service.
- *Prices are subject to change without signed Customer Support Agreement.

CURRENT GENERATOR SERVICE LABOR RATES ARE AS FOLLOWS:

Normal Hour Labor (Monday through Friday, 8:00 A.M. to 5:00 P.M.) \$110.00/Hour
 Overtime Labor \$165.00/Hour
 Holiday Labor \$220.00/Hour

A trip fee per day will apply for work performed outside of this agreement dependent on location.
 The above labor rates are subject to change without notice

This agreement is valid from April 1, 2014 to March 31, 2015 and can be cancelled with a 30-day written notice by either party.
 By signing below, Holt CAT agrees to provide the above-mentioned services at the stated prices for the length of this agreement and gives authorization for the commencement of stated services.

Scott Boddicker

Product Support Sales Representative

Holt

Customer Acceptance Signature

Date



PRODUCT SUPPORT
QUOTE

CAT-ISO.com

Job Name: Webb County Laredo, TX

Quote Number: 049976 rev: 00

Status: Delivered

Delivered: 4/11/14

Dealer: Holt Power Systems

Scott Boddicker

Office: 210-219-4952

Quote valid thru: 5/11/2014

Estimated Ship Date:

DESCRIPTION	Part Number	Unit Price	Unit	Qty	PRICE
Replace failed Beckhoff TSP with new 12" Magelis TS (FS REMEDIAL)		\$35,587.90			\$35,587.90
In House Production (Project Management, Engineering, CAD)		\$18,095.10		1	\$18,095.10
Days for Field Engineer On site		\$3,000.00		1	\$3,000.00
Travel and Lodging Expenses		\$2,537.33		1	\$2,537.33
Shipping		\$600.00		1	\$600.00
Parts		\$11,355.48			\$11,355.48
MAGELIS 12" TOUCHSCREEN, MB+	TS-ISOXBTGT12MB+	\$6,975.00	EA	1	\$6,975.00
MODICON USB TO MB + CONVERTER	PLC-TSXCUSBMP	\$3,801.00	EA	1	\$3,801.00
CUSTOM INS DOOR	DOOR CUST SWG	\$578.88	EA	1	\$578.88

QUOTE TOTAL:

\$35,587.90

TERMS:

This quotation represents a fixed rate price for travel, labor and materials described in this estimate. All work includes CAT Switchgear standard after-market warranty terms and conditions. Applicable taxes, duties and freight are not included and will be added at time of invoice unless otherwise stated. Returned parts are subject to a re-stocking fee. Any additional labor or material required but not included as a result of change in scope will be invoiced as accrued. Canceled orders will be invoiced to include any material return fees, non-refundable travel, and submittal labor if applicable.

GENERAL NOTES AND CLARIFICATIONS:

This proposal is provided to Webb County for requested replacement of existing obsolete Beckhoff touch screen processor with a new 12" Magelis touch screen at the Webb County facility in Laredo TX. The addition of the 12" Magelis touch screen will require door replacement in Section 1, Cells B and C.

DEFINITION OF SERVICES:

- In house
1. Project Management - Communication, planning, logistics.
 2. Engineering - Design, drawing markups.
 3. Graphics - Design.
 4. Logistics - Materials, tools, shipping preparation.

5. CAD - Update drawings with current changes.

On Site

- 1. Replacement of obsolete Beckhoff touch screen processor with new 12" Magelis touchscreen and new cabinet door.**
- 2. System Testing**

Travel and Lodging

- 1. Mileage, Lodging, Travel Labor, etc.**

CAT SWITCHGEAR ROLES/RESPONSIBILITIES:

- 1. One (1) trip for one (1) field engineer on site for one (1) day plus travel and expenses to replace the obsolete Beckhoff touch screen processor with a new 12" Magelis touch screen and new cabinet door.**
- 2. Proposal assumes that work will be performed Monday - Friday during normal business hours, if weekend or after hours work is required please contact the factory for updated pricing. If additional time on site is required for reasons outside CAT Switchgear's control those days will be billed per CAT Switchgear's published rates plus expenses.**
- 3. This proposal is based on the scheduling of a local engineer. If the site's schedule conflicts with the schedule of the engineer, resulting in the necessary use of an alternate engineer, a new quote reflecting additional travel charges must be submitted and approved prior to work being performed.**

Signature of Webb County Representative

Date

Jose E. Gonzalez

From: Tomas Sanchez
Sent: Tuesday, April 29, 2014 9:42 AM
To: Jose E. Gonzalez
Cc: Gabino Cerda; Rose C. Flores
Subject: Capital Outlay request Holt Generators
Attachments: HOLT CSA PM3 all 3 Units 4-11-14.xls; HOLT Switchgear Processor 4-11-14.docx

Importance: High

Follow Up Flag: Follow up
Flag Status: Flagged

Categories: Yellow Category, Red Category

Good morning Joe,

I have called Mr. **Scott Boddicker** from **Holt CAT** in regards if we go with a different Company for the PM3 and Transfer Switch he did say that for the PM any available Warranties left will be Voided for all 3 Generators. For the Transfer Switch he said that a different Company will probably buy it from them as well.

Thank You.

*Tomas Sanchez
Webb County Water Utility
515 Martha Drive
Rio Bravo, Texas. 78046*

*Main Office (956) 523-5590
Direct Number (956) 523-5586
Fax (956) 724-7906*